

MATE

Thermal Imaging Attachment



User Manual

MATE ULTRA S60R / MATE H50R / MATE H38R / MATE LITE L38

V1.0

IMPORTANT SAFETY INFORMATION

Environmental influences

- Never point the lens of the device directly at intense heat sources such as the sun or laser equipment. The objective lens and eyepiece can function as a burning gla
- Avoid touching the metal surface (cooling fins) after exposure to sunlight or cold.

Ergonomics notes

Take breaks after longer periods of use to avoid wrist pain.

Risk of swallowing

Do not place this device in the hands of small children. Incorrect handling can cause small parts to come loose which may be swallowed.

Safety instructions for use

- Handle the device with care: rough handling can damage the internal battery.

- Do not expose the device to fire or high temperatures.
- Install the batteries correctly according to the instruction on the device. Reverse connection is prohibited.
- The battery capacity decreases when operated in a cold ambient temperature. This is not a fault and occurs for technical reasons.
- The recommended temperature for using this product is -20° to +50°. Otherwise, it will affect the service life of the product.
- Do not store the device for long periods at temperatures below -20°C or above 50°C, or it will permanently reduce the battery capacity.
- Always store the device in a dry, well-ventilated space.
- If the device has been damaged or the battery is defective, send the device to our after-sales service for repair.

Safety instructions for the power supply unit

- Check the power supply unit, cable and adapter for visible damage before use.
- Do not use any defective parts. Defective components must be replaced.
- Do not use the power supply unit in wet or humid environments.

- Only charge the device at temperatures ranging between 0°C and 50°C.
- Do not make any technical modifications.

Disposal of batteries



Directive 2006/66/EC (battery directive): This product contains a battery that cannot be disposed of as unsorted municipal waste in the European Union. For battery details, refer to the documentation of the specific product. The battery is marked with this symbol, which may include Cd (indicating cadmium), Pb (indicating lead), or Hg (indicating mercury). For proper recycling, please return the battery to your supplier or send it to a designated collection point. For more information, visit www.recyclethis.info.

User information on the disposal of electrical and electronic devices (private households)



2012/19/EU (WEEE directive): Products marked with this symbol cannot be disposed of as unsorted municipal waste in the European Union. For proper recycling, return this product to your local supplier upon the purchase of equivalent new equipment, or dispose of it at designated collection points. For more information see: www.recyclethis.info.

For business customers within the European Union

Please contact your dealer or supplier regarding the disposal of electrical and electronic devices. He will provide you with further information.

Information on disposal in other countries outside of the European Union

This symbol is only applicable in the European Union. Please contact your local authority or dealer if you wish to dispose of this product and ask for a disposal option.

Intended use

The device is intended for displaying heat signatures during nature

observation, remote hunting observations and for civil use. This device is not a toy for children.

Use the device only as described in this operating manual. The manufacturer and the dealer accept no liability for damages which arise due to non-intended or incorrect use.

Function test

- Before use, please ensure that your device has no visible damage.
- Test to see if the device displays a clear, undisturbed image.

- Check that the settings for the thermal imaging monocular are correct. See the notes in the section **Power On and Image Settings**.

Installing/Removing the battery

The MATE Thermal Imaging Attachment is equipped with two power supply systems - one built-in battery pack and one replaceable 18650 battery. The built-in battery pack cannot be removed.

1 Specifications

Model	MATE LITE L38	MATE H38R	MATE H50R	MATE ULTRA S60R
Detector Specifications				
Type	Vox	Vox	Vox	Vox
Resolution, Pixels	384×288	640×512	640×512	1280×1024
Pixel Size, um	12µm	12µm	12µm	12µm
NETD, mK	≤ 15	≤ 15	≤ 15	≤ 15
Frame Rate, Hz	60	60	60	60
Optical Specifications				
Objective Lens, mm	38/F1.0	38/F1.0	50/F1.0	60/F1.0
Field of View (H×V), °	6.9×5.2	11.6×8.7	8.6×6.6	14.7×11.7
Linear Field of View (H×V), m @ 100m	12.3×9.2	20.5×15.4	15×11.5	25.6×20.5
Eye Relief, mm	20	20	20	20
Exit Pupil Diameter, mm	35	35	35	35
Detection Range, m(Target Size: 1.7m×0.5m, P(n)=99%)	1950	1950	2600	3100
Display Specifications				
Type	AMOLED	AMOLED	AMOLED	AMOLED
Resolution	1920×1080	1920×1080	1920×1080	1920×1200
Battery Power Supply				

Battery	Replaceable 18650 battery	Replaceable 18650 battery	Replaceable 18650 battery	Replaceable 18650 battery
Max. Operating Time (22°C), h*	6	4	4	4
External Power Supply	5V (Type C)	5V (Type C)	5V (Type C)	5V (Type C)
Physical Specifications				
Wi-Fi / APP	Support	Support	Support	Support
Photo / Video Recorder	Support	Support	Support	Support
RAV	Support	Support	Support	Support
Gallery	Support	Support	Support	Support
N-link	Support	Support	Support	Support
Remote	Support	Support	Support	Support
MAGIC ZOOM	NA	Support	Support	Support
Memory Capacity	64GB	64GB	64GB	64GB
IP Rating	IP67	IP67	IP67	IP67
Operating Temperature, °C	-20 ~ +50	-20 ~ +50	-20 ~ +50	-20 ~ +50
Weight (with battery), g	399	457	467	560
Dimension, mm	115x72x76	115x85x76	120x92x76	140x96x78
Connections and Compatibilities				
Max. Recoil Power on Rifled Weapon (Eo), Joules	7000	7000	7000	7000
Adapter Interface	M52	M52	M52	M52
Safety Class for LRF	NA	Class 1	Class 1	Class 1
LRF Measuring Range, m	NA	1200, ±1	1200, ±1	1200, ±1

Ballistic Calculation	Support	Support	Support	Support
-----------------------	---------	---------	---------	---------

- ★ The actual battery life depends on the use frequency of functions like Wi-Fi, LRF, etc.
- Improvements may be made to the design and software of this product to enhance its features without prior notice.
- The newest user manual can be downloaded at our official website: www.nocpix.com.

2 Package Contents

- MATE Series Thermal Imaging Attachment
- Remote Control Accessories
- MAGIC ZOOM *
- 3x18650 battery *
- Battery charger
- Type-C cable
- Heated target for zeroing * 10
- Lens cloth
- Quick start guide
- Portable bag

Note:

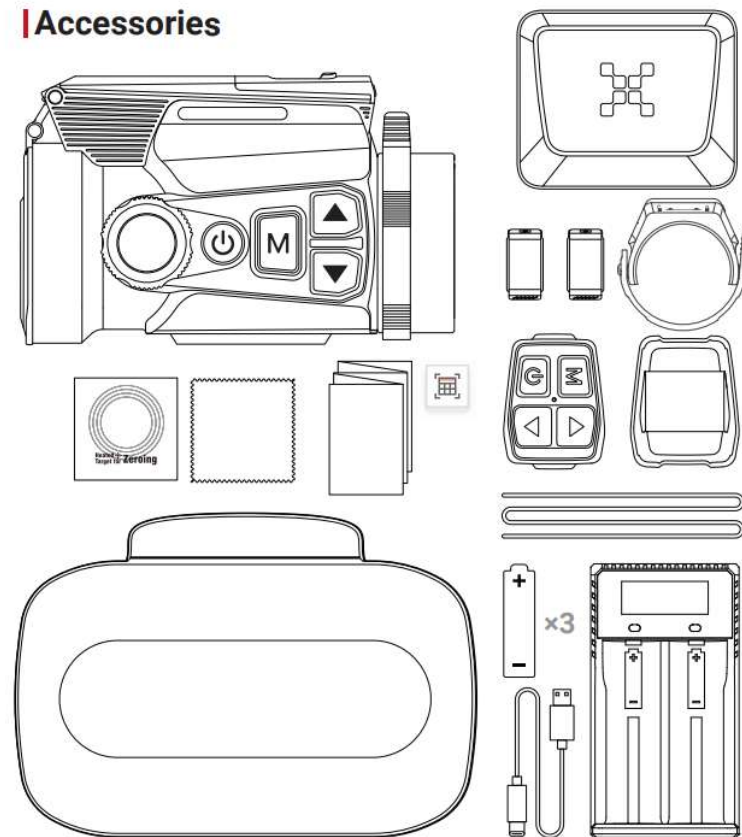

* 4x18650 battery for MATE ULTRA S60R, 2x18650 battery for MATE LITE L38

3 Description

MATE series is a thermal imaging attachment for outdoor hunting. Designed based on infrared thermal imaging principles, it requires no external light sources during the day and at night, in all hard weather conditions (such as rain, snow, fog, and haze). It can be used without being affected by strong light and to observe even targets behind obstacles (such as branches, grass, and shrubs).

4 Features



- Integrated LRF
 - Ballistic Calculation
 - Recoil Activated Video function
 - Gallery function
 - Remote controller
 - MAGIC ZOOM function
 - Zeroing by APP
 - Built-in memory, supporting photographing, video recording
 - Built-in motion sensor
 - Shutless function
 - Pixel defect correction
- 15mK NETD

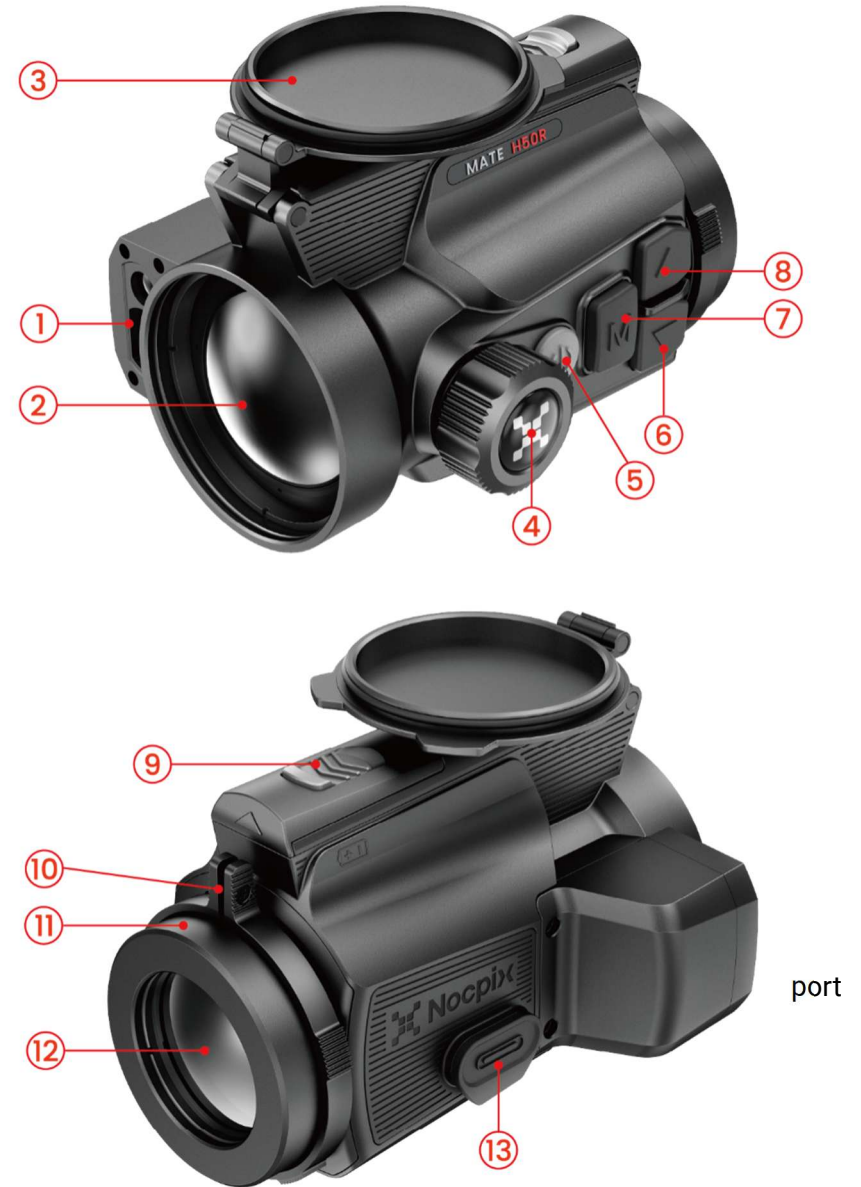

5 Components and Controls

1. LRF
2. Lens
3. Lens cover
4. Lens focus knob
5. Power button
6. Down button
7. Menu button
8. Up button
9. Battery cover
10. Adapter locked ring
11. M52 * 0.75 connection thread
12. Eyepiece
13. Type-C



6 Button Operation

Button	Current Status	Short Press	Long Press
Power Button 	Powered off	--	Power on the device
	Home screen	Image calibration	On the Home screen, a 3-2-1 countdown prompt appears. <ul style="list-style-type: none"> ➤ If the Power button is released during the countdown, the device enters into Standby mode. ➤ When the countdown completes, the device will power off.
	Continuous range	Exit continuous range	
	Shortcut Menu/Main Menu interface	Return to home screen / Return to the previous interface without saving	
Up Button (H38R / H50R / S60R) 	Home screen	Perform a single range	Continuous LRF is ON: Long press Up button to start continuous range Continuous LRF is OFF: Long press Up button and then release it to perform a single range
	Zeroing interface	Move one pixel to the Up every time	Move 10 pixels to the Up every time
	Shortcut Menu/Main menu interface	Scroll up options	---
	Home screen	Switch the image mode	---
Up Button (L38) 	Zeroing interface	Move one pixel to the Up every time	Move 10 pixels to the Up every time
	Shortcut Menu/Main menu	Scroll up options	---
	Home screen	Switch the image mode	---

	interface		
Down Button 	Home screen	Short press : UI zooming Double click : Capture	Start video recording
	Zeroing interface	Move one pixel to the Down every time	Move 10 pixels to the Down every time
	Shortcut Menu/Main menu interface	Scroll down options	---
Menu Button 	Home screen	Enter the Shortcut Menu interface	Enter the Main Menu interface
	Shortcut Menu interface	Adjust parameters	Save and back to the Home screen
	Main Menu interface	Adjust parameters / Enter the submenu	
	Zeroing interface	Switch the movement direction	

7 Power Supply

MATE uses one 18650 battery, the battery should be fully charged before the first use.

Battery Install

Please install the 18650 battery correctly according to the following polarity markings.

Battery Install

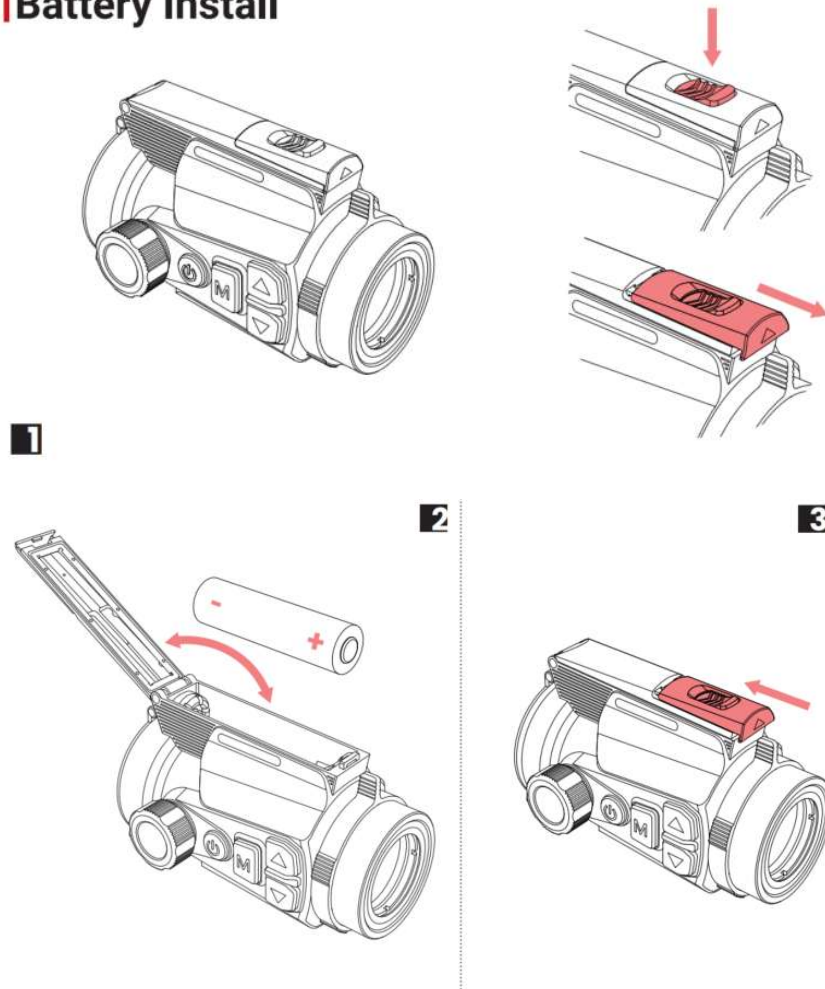

Note: The replaceable 18650 battery can be charged by 18650 battery charger or via Type C port.

Safety precautions

- When charging, please use the 5V2A power adapter compatible with the device. Using any other type of adapter may cause irreversible damage to the battery or the adapter itself.
- If the device is not used for a long time, the battery should be partially charged, not fully charged or discharged.
- Do not charge the device immediately after it is moved to a warm environment from a cold environment. Wait for 30 to 40 minutes for preheating.
- Do not use the charger if it is modified or damaged.
- The device should be charged at a temperature of 0°C to +40°C. Otherwise, the battery life will be significantly reduced.
- When charging, please do not leave the battery unattended.
- Do not connect the battery to the power supply for more than 24 hours after it is already fully charged.
- It is not recommended to connect third-party devices that consume more energy than the allowed value.
- The device is equipped with a short circuit protection system, but conditions that may lead to a short circuit should be avoided.

- Use the device at the recommended operating temperature from -20°C to +50°C. Do not use the device beyond this temperature range, or otherwise, the use may shorten the battery life.
- When the device is used under sub-zero temperature, the battery capacity drops. This is normal and does not indicate a defect.

8 Usage

Powering on and off

- Press and hold the **Power button** for 2s to start the device.
Wait for 3s to complete the startup.
- Rotate the **Lens focus ring** to focus on the object to be observed.
- On the Home screen, short press the **Menu button** to enter the shortcut menu.
- Long press the **Menu button** to enter main menu.
- On the Home screen, press the **Power button** for image calibration. When performing background calibration, please cover the lens cap.
- Please set the calibration mode in main menu.

- On the Home screen, press and hold the **Power button** to initiate a 3-2-1 countdown prompt. When the countdown completes, the device will power off.
- If the **Power button** is released during the countdown, the device will enter Standby mode, indicated by a standby icon.
- On the standby screen, either short press or long press the **Power button** will wake up the device.

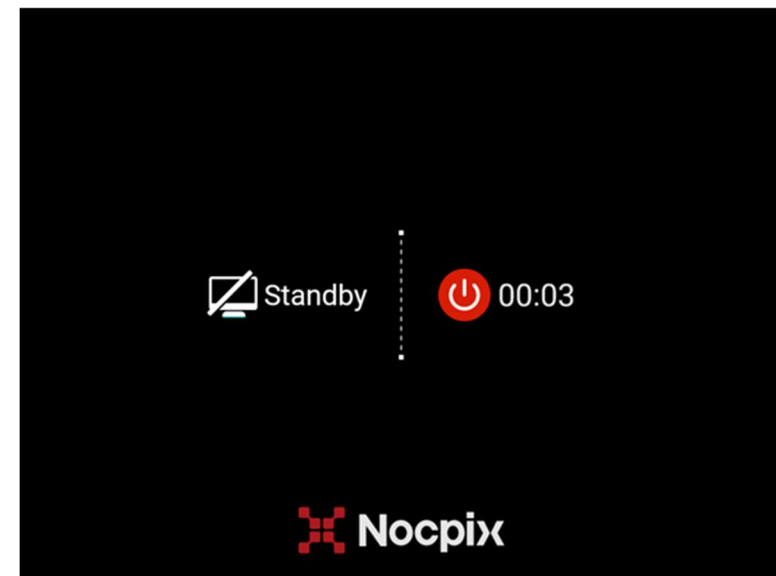

9 Installation

MATE series can be used as a monocular or front attachment for day scope. Original design allows the monocular to be quickly converted into attachment and vice versa.

As a front attachment

MATE as an attachment is designed to use a day scope both in the nighttime and daytime in inclement weather (fog, smog, rain etc.).

When use as a front attachment, please ensure MATE is in attachment mode, in which the status bar at the bottom of the screen shows profile 1/2/3/4/5/6/7/8.

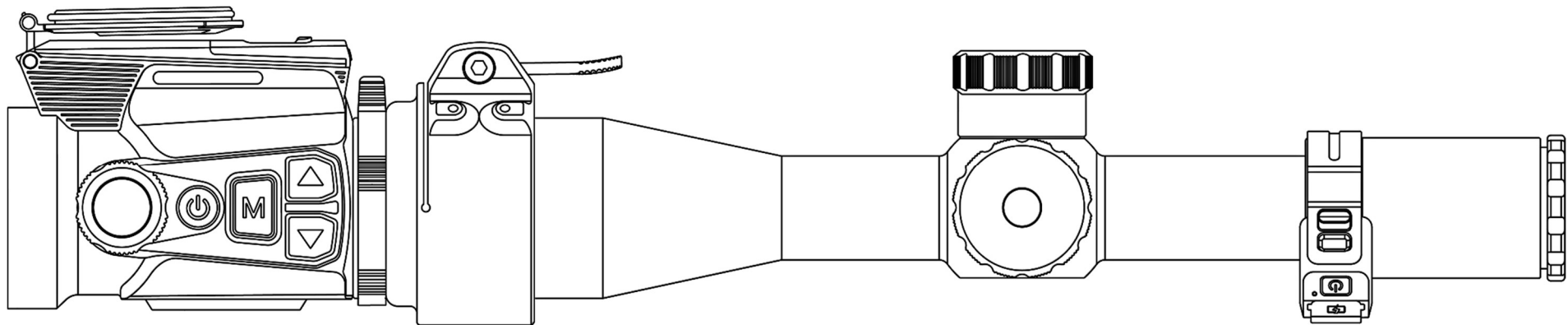
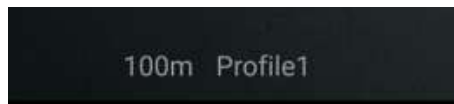

To mount it on a day device, please follow instructions as follows:

- Please make sure that the day scope is zeroed before installation.
- Measure the outer diameter of the lens of your day scope.
- According to the outer diameter of the objective lens of your day scope, choose a suitable adapter (bought separately) with M52*0.75 internal thread.
- Screw the selected adapter onto the eyepiece of the MATE.
- Install firmly the adapter with MATE together onto the objective lens of your day scope.
- Then you can use MATE as a front attachment.

As a monocular

- When used as a monocular, it needs to switch to the monocular mode, in which the status bar at the bottom of the screen will not display the profile.

10 Status Bar Icons

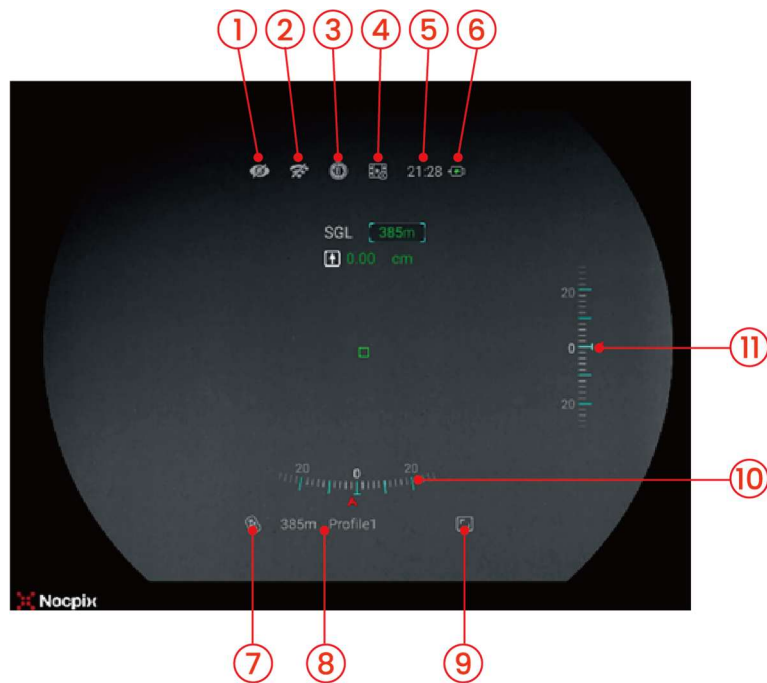

1. Ultraclear mode status: (: The Ultraclear mode is off. : The Ultraclear mode is on.)
2. WIFI status (: Wi-Fi OFF. : Wi-Fi ON)
3. Image calibration status (: Auto Calibration. : Manual Calibration. : Background Calibration)
4. Recoil Activated Video(: RAV is OFF. : RAV is ON)
5. Time (Set it in the Main Menu or NOCPPIX APP)
6. Battery ()
7. Remote Controller (The icon is only displayed when the remote control is connected)
8. Zeroing distance and Profile (You can renamed the profile via NOCPPIX APP; such as **100m .308Win**)
9. MAGIC ZOOM (The icon will be displayed when MAGIC ZOOM is connected, and will not be displayed when MAGIC ZOOM is not connected) ;
10. Horizontal tilt angle
11. Vertical tilt angle

11 Zeroing (only for Attachment mode)

When MATE is installed on the day scope as an infrared extension component, if the target of the infrared image changes from the reticle of the original day scope, you need to use the zeroing function to zero MATE.

- Please finish the zeroing of the day scope firstly before mounting MATE.
- Install MATE on the day scope referring to the Installation section.
- Set the profile to 1,2,3,4,5,6,7 or 8 in "Zeroing" option.



- Select a suitable target distance. The default setting is 100m. You can also modify this distance.

You can also select the zeroing distance, then short press the Menu button to select the LRF mark with the cursor, and then short press the Up button(LRF button) to directly set the actual LRF distance as the zeroing distance directly.



- Shooting at the target, if the POI does not match the reticle of day scope, select the Image Freeze icon in Zeroing menu, short press the Menu button to freeze the image.

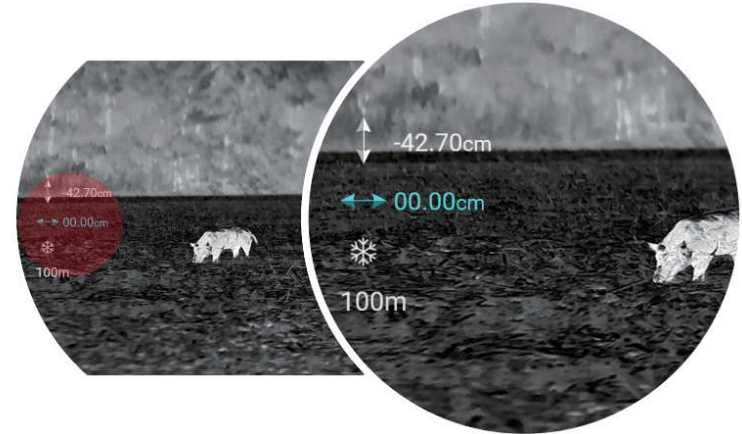
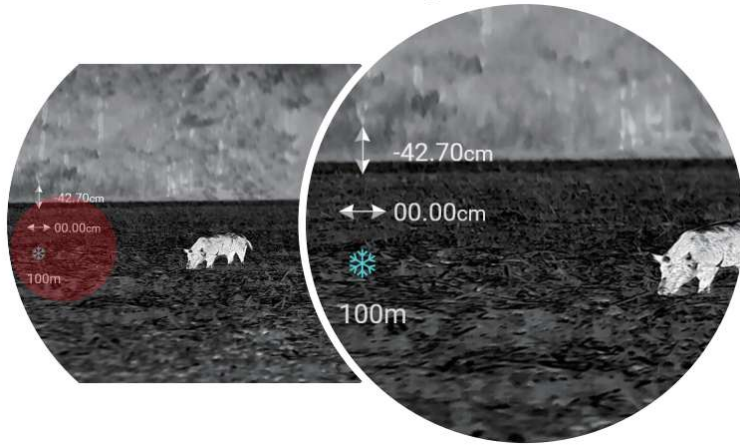

- Calibrate the position of the image:
 - a. Short press the Up or Down button to select Up/Down or Left/Right direction, the selected direction will turn blue
 - b. Short press the Menu button confirm the direction. When the direction arrow flashes, short or long press the Up/Down button to move the image on this direction.

- c. When the POI matches the reticle of day scope, long press the Menu button to save the position and exit the zeroing interface.



- Shoot again to check the POI matches the reticle of day scope or not. If not, do the zeroing again

12 Photo and Video Recording

The MATE series supports capture and video recording. Double click the **Down button** to take a picture, press and hold the **Down button** to record a video.

Each time a photo is taken, the camera icon on the display will flash once.

Each time a video is recorded, a camcorder icon will appear on the display, along with the recording time.

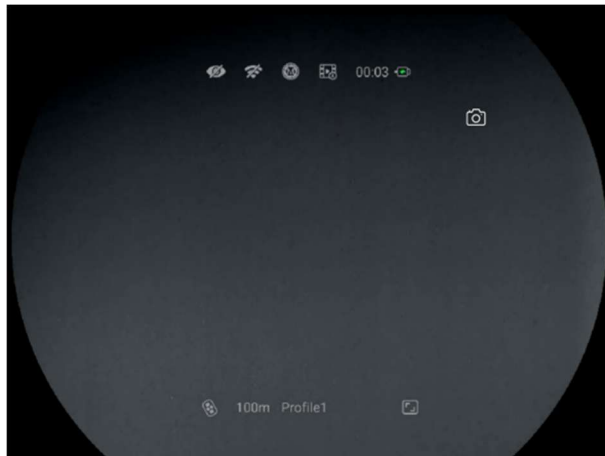



Memory access

When the device is powered on and connected to a computer, it will be



recognized by the computer as a flash memory card.

Then, you can access the memory of the device and copy images and videos.

- Connect the device to a computer through the USB cable.
- Power on the device.
- Double-click My Computer, double-click to open the device named **NOCPPIX**  , double-click to open the device name **MATE H50R**  to access the memory.
- There are different folders named by date in the format of xxxx (year) xx (month) xx (day) in the memory.
- Recorded photos and videos in that day are saved in the folders.
- Select desired files or folders to copy or delete..

13 UI zooming

In order to adapt to different day scopes with different magnification, MATE has 4 different UI gears, and you can short press the Down button to switch different UI gears;



14 LRF (MATE ULTRA S60R / MATE H50R / MATE H38R)

Within the LRF option in the main menu, you can choose to turn on or off the Continuous LRF function.

- When Continuous LRF is ON, short press the Up button for single ranging, long press the Up button for continuous ranging
- When Continuous LRF is OFF, short press the Up button for single ranging, long press the Up button and release it to trigger single ranging

Note: Ballistic Calculation can only be performed when performing single ranging.



Single ranging

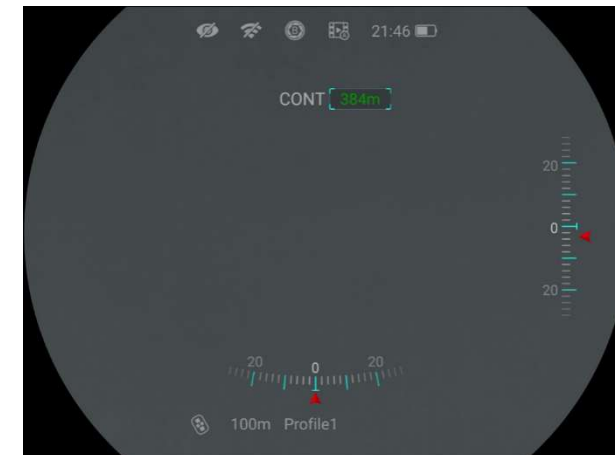

Continuous ranging

15 MAGIC ZOOM (MATE ULTRA S60R / MATE H50R / MATE H38R)

The MATE series supports the MAGIC ZOOM function, which has two functions:

1. During the day scope zooming in, the UI icon can always be seen through the eyepiece of the day scope
2. During the day scope zooming in, the image quality will be improved by R+ automatically when observing through the high-magnification day scope

Connection: (When you receive a new MATE, MAGIC ZOOM and MATE are already connected in factory. If you replace a new MAGIC ZOOM accessories or upgrade the MATE program in the future, MAGIC ZOOM needs to be connected to MATE again)

1. Install MATE in front of the day scope; select a suitable strap to fix MAGIC ZOOM on the magnification adjustment ring of the day scope; and install the battery of MAGIC ZOOM;



2. Turn on MATE, press and hold the power button of MAGIC ZOOM for 3 seconds, the MAGIC ZOOM light will turn green and then turn off, indicating that MAGIC ZOOM has been turned on;
3. After the MAGIC ZOOM is turned on, short press the MAGIC ZOOM power button for 6 times in a row. The red light will flash for each of the first 5 short presses. After the 6th short press, the red light will turn on for 3 seconds and then turn off, indicating that MAGIC ZOOM has started to connect with MATE;
(Press the power button of MAGIC ZOOM 6 times should be within the first 90 seconds of MATE turning on)

4. Wait for 10 seconds, the MAGIC ZOOM icon will appear in the bottom right corner, indicating that MAGIC ZOOM has been successfully connected to MATE;
5. After the connection is successful, short press the MAGIC ZOOM power button. The green light indicates that the battery is full power, and the red light indicates that the battery needs to be charged in time;



Calibration:

1. Open the MAGIC ZOOM option in the main menu, and the prompt "MAGIC ZOOM Calibration?" will pop up.
Press the Menu button to select Yes to perform MAGIC ZOOM calibration; or select No to exit the calibration process. During the

calibration process, please keep the rifle within 30 degrees of vertical tilt angle.

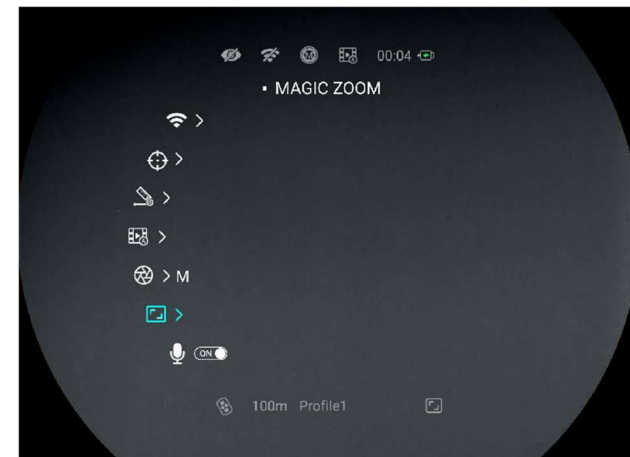
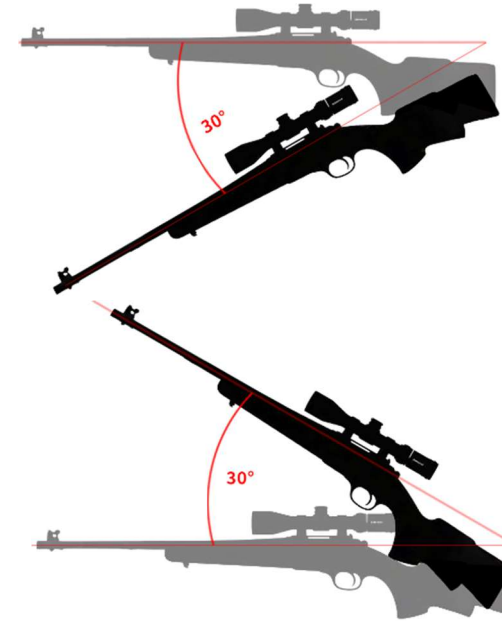

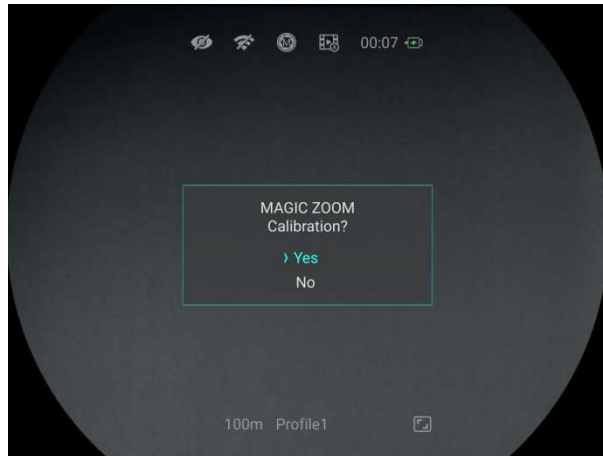

2. Please make sure the MAGIC ZOOM has been fixed on the magnification adjustment ring of the day scope, then click “NEXT” by Menu button.

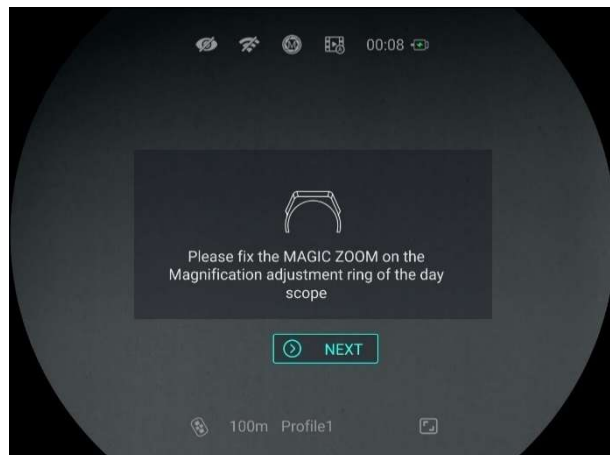

3. Please adjust the day scope to 3X, then click “NEXT” by Menu button, (If your day scope does not have a 3X magnification, please adjust it to the closest magnification to 3X)

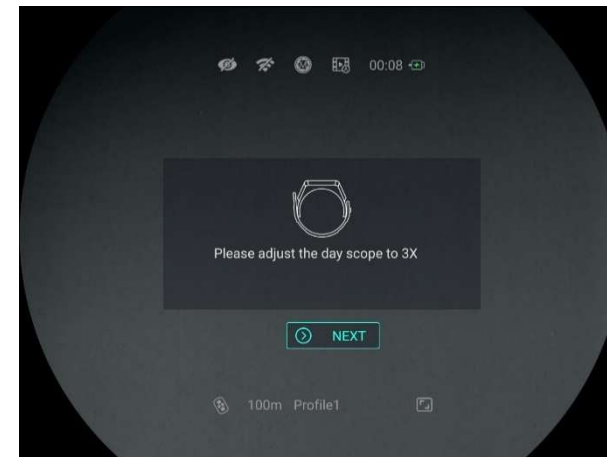

4. Please adjust the day scope to 6X, then click “NEXT” by Menu button, (If your day scope does not have a 6X magnification, please adjust it to the closest magnification to 6X)

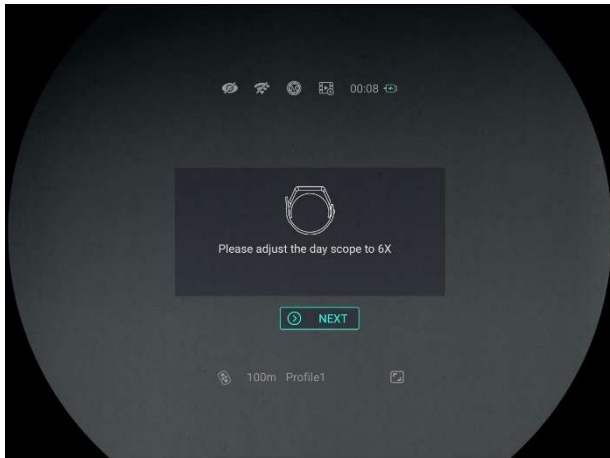

5. Please adjust the day scope to 9X, then click "NEXT" by Menu button, (If your day scope does not have a 9X magnification, please adjust it to the closest magnification to 9X).

Then the prompt "Calibration completed, Let's start MAGIC ZOOM" will pop up, indicating that MAGIC ZOOM has been calibrated and can be used normally.

Note:

After MAGIC ZOOM is calibrated, if the battery is low, just replace a MAGIC ZOOM battery, don't remove MAGIC ZOOM from the day scope.

If MAGIC ZOOM is removed from the day scope, you need to recalibrate it again.

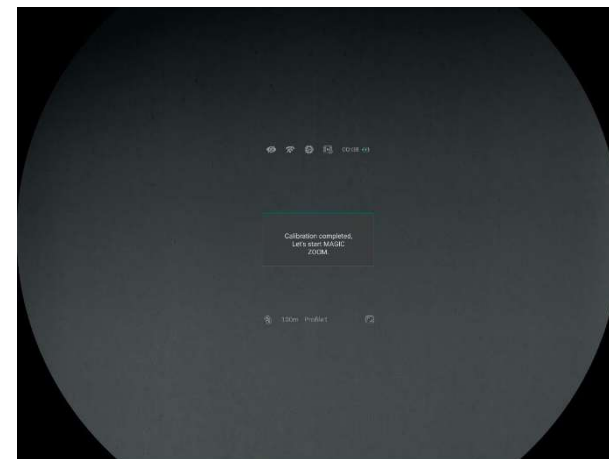
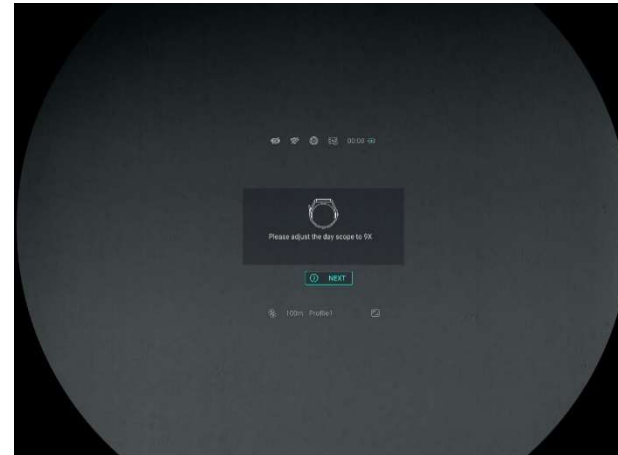

16 Remote

The MATE series supports Remote function, when you receive a new MATE, Remote and MATE are already connected in factory.

If you replace a new Remote accessories in the future, Remote needs to be connected to MATE again.

Connection:

1. Power on MATE, press and hold the M and Down buttons simultaneously for 10 seconds, and then the remote controller will automatically connect to the MATE.
2. The remote icon will appear in the bottom left corner, indicating that remote has been successfully connected to MATE.

17 Shortcut Menu

Short press the Menu button to open the Shortcut Menu;

Within the Shortcut Menu options, press Up or Down button to switch between different shortcut menu options. Icons change from white to blue when a Shortcut Menu option is selected.



Press the Menu button to adjust the parameter settings of the Shortcut Menu;



If there is no operation for 7 seconds, the Shortcut Menu will exit automatically. You can also exit the Shortcut Menu by pressing and holding the Menu button or pressing the Power button.





Within the Shortcut Menu options, you can perform the following settings:



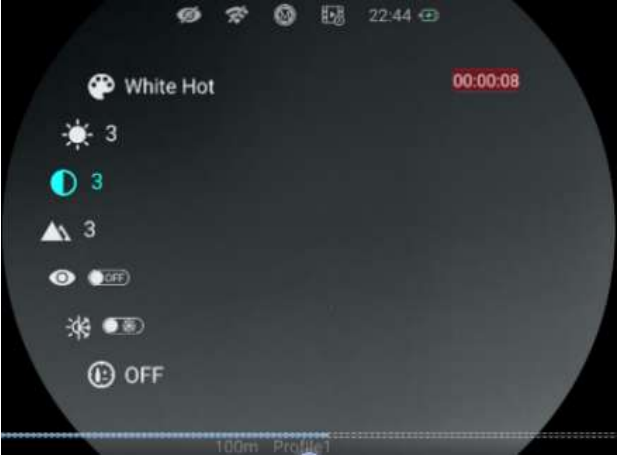

- **Color mode:** short press the Menu/Up or Down button to switch the image mode
- **Brightness:** short press the Menu /Up or Down button to switch the screen brightness from level 1 to level 6.

- **Image Contrast:** short press the Menu/Up or Down button to switch the image contrast from level 1 to level 6.
- **Image Sharpness:** short press the Menu/Up or Down button to switch the image sharpness from level 1 to level 6
- **Ultra Clear:** short press the Menu/Up or Down button to switch the Ultra Clear to ON or OFF
- **Image Hue:** short press the Menu/Up or Down button to switch the Image Hue to warm or cold
- **Pre set BC distance:** short press the Menu/Up or Down button to Pre set BC distance as 200m/225m/250m/275m/300m/OFF

<p>Color Mode</p> 	<ul style="list-style-type: none"> ● Within the Color Mode options, short press the Menu button to switch between different color modes. ● The color modes include: White Hot, Black Hot, Red Hot, Rainbow, Violet, Crimson, and Viridian. ● Note: Only the MATE H38R / H50R/ S60R models have the Color Mode option in Shortcut Menu. 	
---	---	--

<p>Brightness</p> 	<ul style="list-style-type: none">● Within the Brightness options, short press the Menu button to switch between different screen brightness levels.● Screen brightness has 6 levels to choose from, we recommend a screen brightness of 3 
<p>Image Contrast</p> 	<p>Within the Image Contrast options, short press the Menu button to switch between different Image Contrast levels.</p> <ul style="list-style-type: none">● Image Contrast has 6 levels to choose from, we recommend a contrast level of 3. 

<p>Image Sharpness</p> 	<ul style="list-style-type: none"> ● Within the Image Sharpness options, short press the Menu button to switch between different sharpness levels. ● Image Sharpness has 6 levels to choose from, we recommend a sharpness level of 3. 
<p>Ultra Clear</p> 	<ul style="list-style-type: none"> ● Within the Ultra Clear options, short press the Menu button to switch Ultra Clear mode as ON or OFF. <p>We recommend to enable Ultra Clear mode on cloudy and rainy days to effectively enhance image quality.</p> 

<p>Image Hue</p> 	<ul style="list-style-type: none"> ● Within the Image Hue options, short press the Menu button to switch Image Hue as Warm or Cold. <p>Cold hue mode Image will be more contrast, more hierarchy, and more obvious targets.</p> <p>Warm hue mode Image will be softer. It can reduce the visual fatigue of the observer, and long time observation is not dazzling.</p> 
<p>Pre-set BC Distance</p> 	<p>For MATE LITE L38, as well as in extremely severe rainy and snowy weather conditions for MATE H38R / MATE H50R and MATE ULTRA S60R when the ranging performance is reduced, you can pre-set the BC distance within this option, and continue to use the BC function.</p> <ul style="list-style-type: none"> ● Within the Pre-set BC Distance options, short press the Menu button to switch the BC Distance as 200m/225m/250m/275m/300m/OFF. ● When OFF is selected, the Pre-set BC Distance function is OFF. ● When 200m/225m/250m/275m/300m is selected, Ballistic Calculate will be performed according to the selected distance. 

The distance can be modified within Zeroing – Profile – BC Distance.

- When "+" is selected, press and hold the Menu button to add a new BC Distance.
- When Pre-set BC Distance is enabled, short-press the Power button, Standby , press the Menu button, or shutting down the device will automatically exit BC Distance.

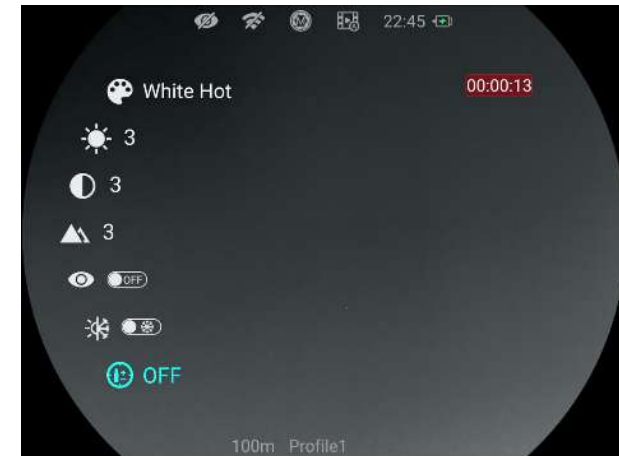

18 Main Menu



Press and hold the **Menu** button to open the **Main Menu**;

Within the **Main Menu** options, press Up or Down button to switch between different main menu options. Icons change from white to blue when a Main Menu option is selected.

Press the **Menu** button to adjust the parameter settings of the **Main Menu**;

If there is no operation for 7 seconds, the **Main Menu** will exit automatically. You can also exit the **Main Menu** screen by pressing and holding the **Menu** button or pressing the **Power** button.

Within the **Main Menu** options, you can perform the following settings:

<p>WIFI</p> 	<ul style="list-style-type: none"> ● Within the WIFI option, press the Menu button to enable or disable WIFI / N-link function. <p>WIFI:</p> <ul style="list-style-type: none"> ● After the Wi-Fi function is on, search for the Wi-Fi signal with the name "MATE H50R_XXXXXXX" on the mobile device. ● Select the Wi-Fi and enter the password to connect. The initial password is 12345678. ● When Wi-Fi is successfully connected, it supports to control the MATE via the NOCPPIX APP downloaded in the mobile device. ● Setting Wi-Fi name and password ● The name and password of the Wi-Fi in MATE series can be reset on the Nocpix app. ● After the scope is connected to a mobile device, locate and click the 'Settings' icon on the Nocpix image screen to enter the WiFi setting interface ● In the text box, enter and submit the new Wi-Fi name (SSID) and password. ● It needs to reboot the device to take the new name and password effect. <p>Note: If the device is reset to the factory settings, the name and password of the Wi-Fi will also be restored to the default settings.</p>	
--	---	---

N-link:

- The N-LINK feature enables interconnection between two NOCPPIX-branded devices, allowing them to exchange ranging data. If the paired device lacks an LRF (Laser Range Finder) function, N-LINK can share ranging information to achieve distance measurement sharing and ballistic calculation.
- Turn on the WIFI function of another NOCPPIX device that supports N-LINK function.
- Turn on the N-LINK function of the MATE device, find the hotspot name of the WiFi device, and press the M key to confirm the connection. After the connection is successful, there will be a ✓ sign.

Note: In this connection process, no matter who is connected to whom, the interconnection function can be realized.

- For MATE rangefinder models,, short press the LRF button to perform a single ranging.
- At this time, the interconnected device will receive the single ranging number and the current screen transmitted by MATE.
- If the Ballistic calculation function is turned on in another device, the Ballistic calculation can be performed through the transmitted ranging number.



Zeroing



- Within the Zeroing option, press the Menu button to enter Zeroing.

Please refer to Zeroing section for details



- Set the Ballistic Calculation to ON or OFF

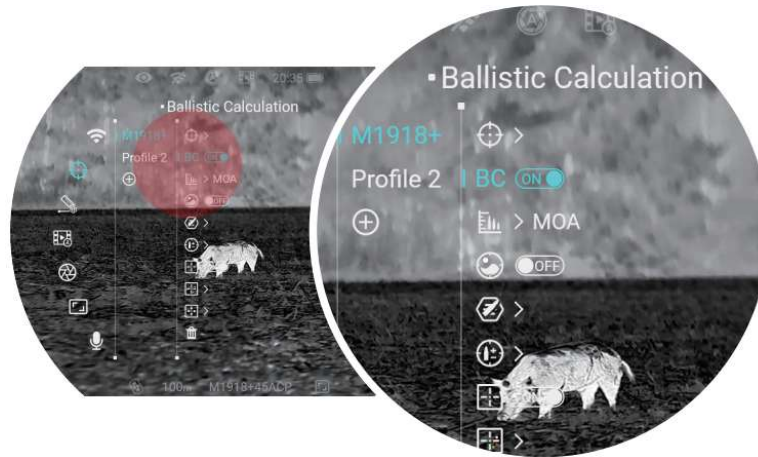

- Set the BC unit to MOA or mil, cm or inch

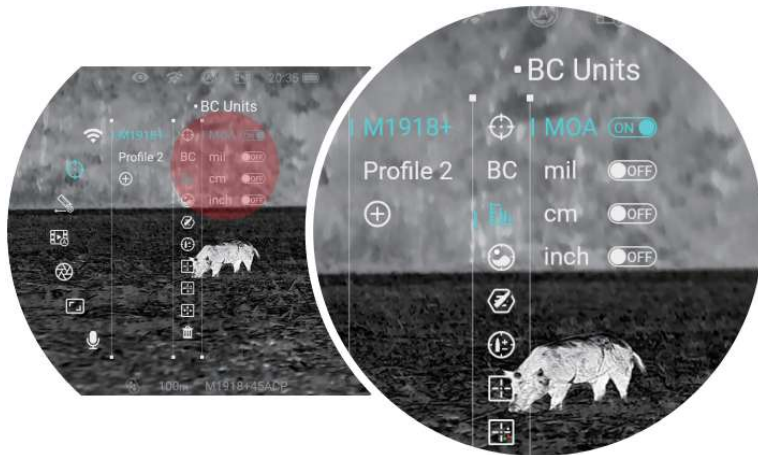

- Set the BC Image Calibration as ON or OFF.

- When BC Image Calibration is OFF, MATE will prompt the offset of the bullet point based on the result of the Ballistic

Calculation;

As shown in the figure, the zeroing distance is 100m, and the BC result of 145m is **2.7cm** up. The hunter needs to calculate the scale value marked on the day scope for **2.7cm** up, then aim and shoot according to the new scale position on the day scope ;



- When BC Image Calibration is ON, MATE will automatically adjust the zeroing distance to the actual LRF distance based on the result of BC, without displaying the offset of the POI. Hunters do not need to calculate and can still aim via the reticle center of the day scope.

As shown in the figure, the zeroing distance has been set to 146m according to the actual LRF distance, and there will be a prompt of "BC Image Calibrated" "**Zeroing Distance: 146m**";

- There are the following ways to exit the current BC Image Calibrated mode and return to the default zeroing distance:
 1. Press power button to exit
 2. Enter Shortcut menu or main menu
 3. Tilt MATE to be standby

The prompt of "BC Image Calibrated" "**Zeroing Distance : 146m**" will disappear , it indicates that the BC Image Calibrated mode is exited, and restore to your initial zeroing distance of 100m

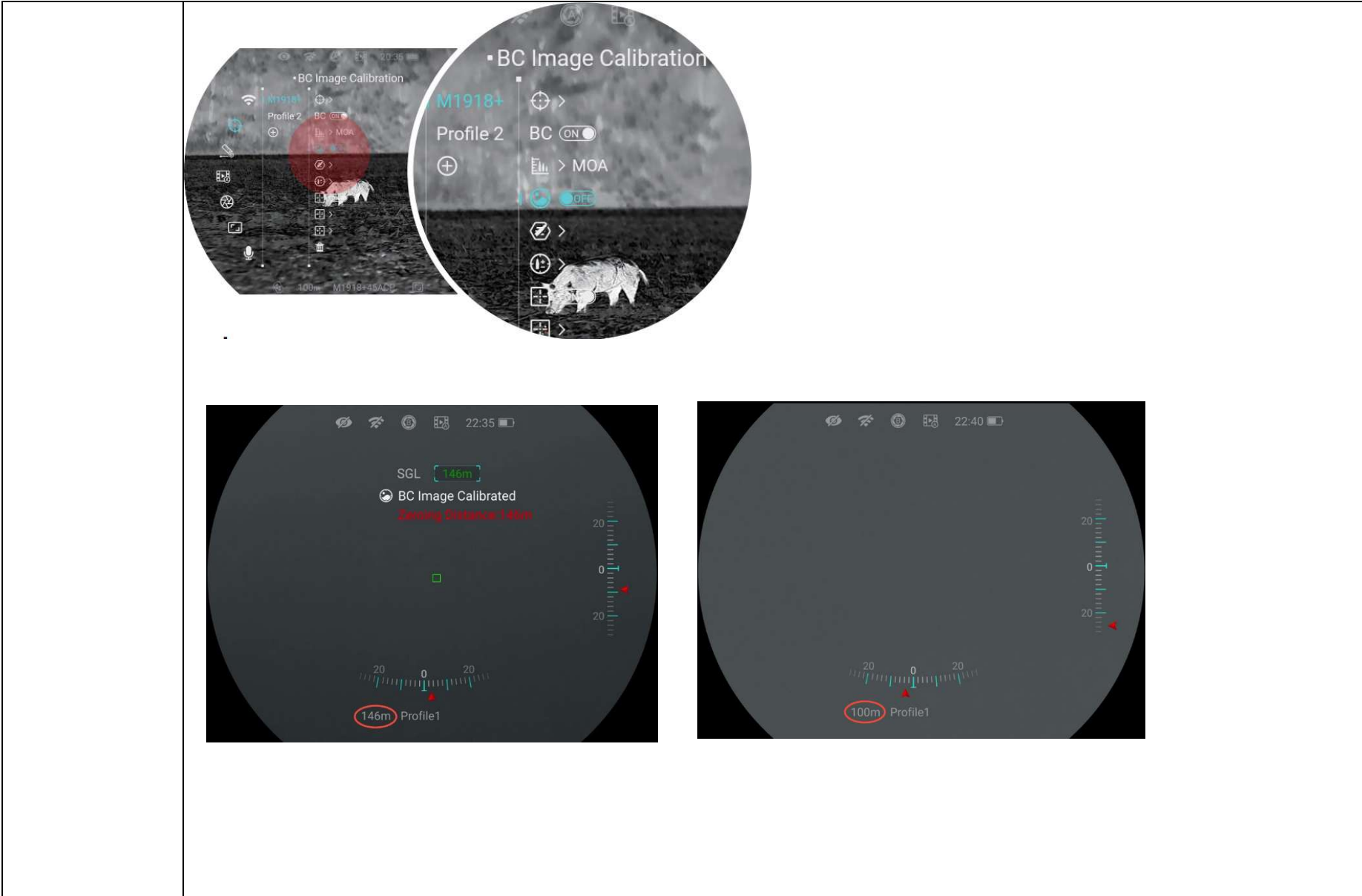

- Set the BC Parameters

BC Parameters can also be adjusted through the NOCPPIX APP

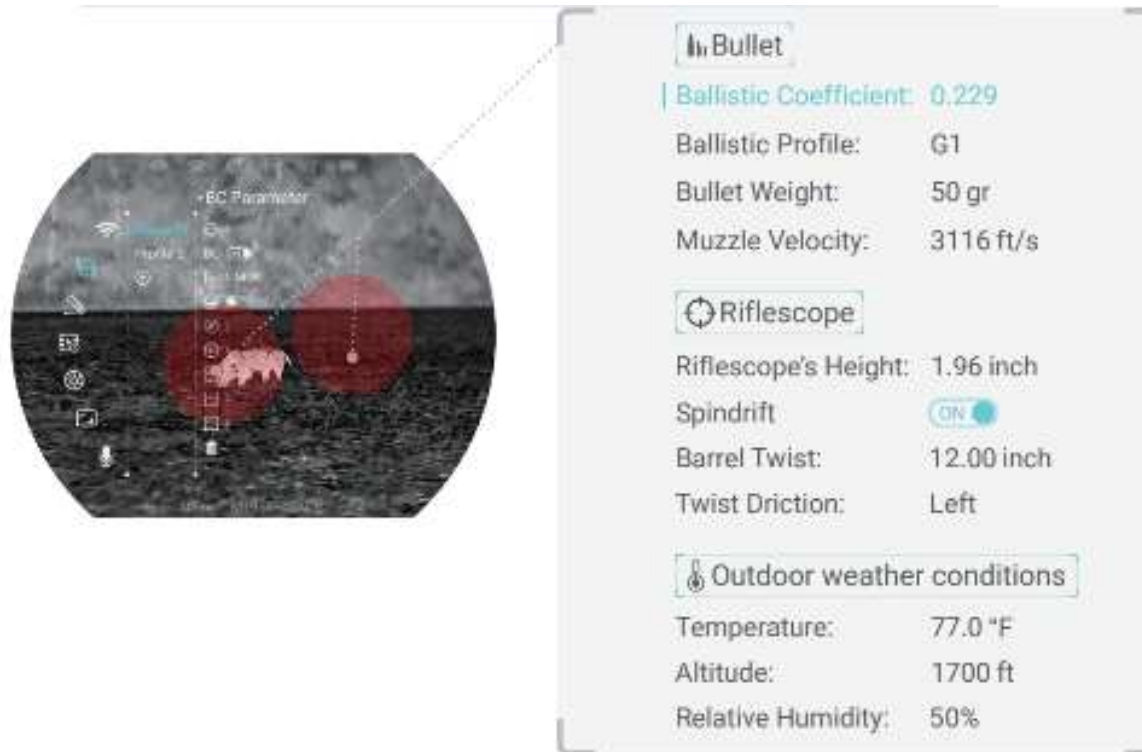

- Pre-set BC Distance

BC distance includes 200m / 225m / 250m / 275m / 300m, after selecting the distance, you can press the Menu button to modify the distance value. The modified distance value will be synchronized to the shortcut menu.

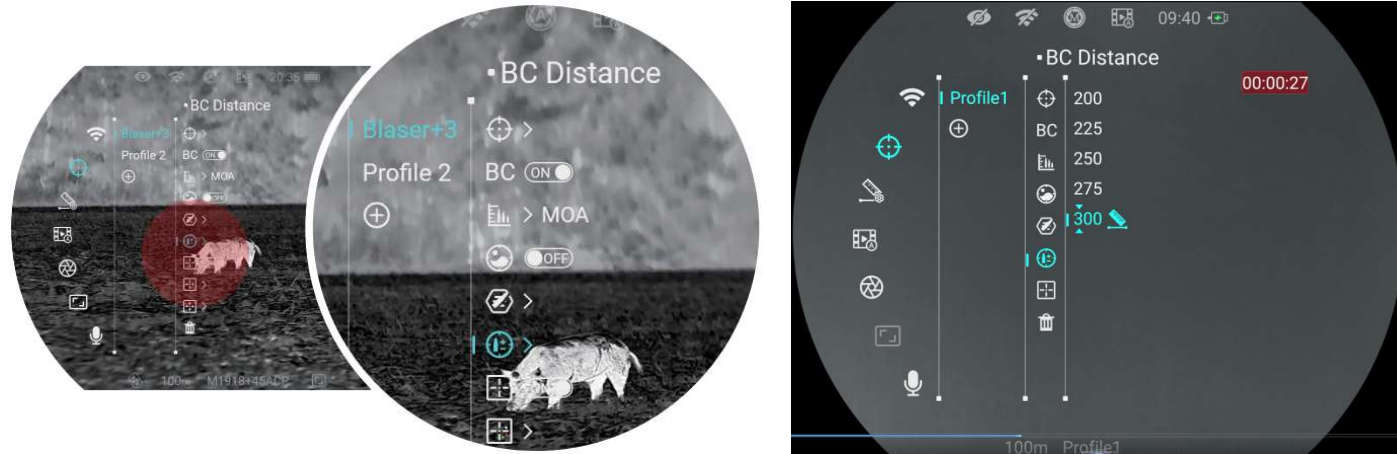

- Ref. Line ON / OFF

When Ref. Line is ON, you can see it in the video recordings.

Due to laws and regulations, the Ref. Line will be suspended when the live view is enabled through the NOCPPIX APP.

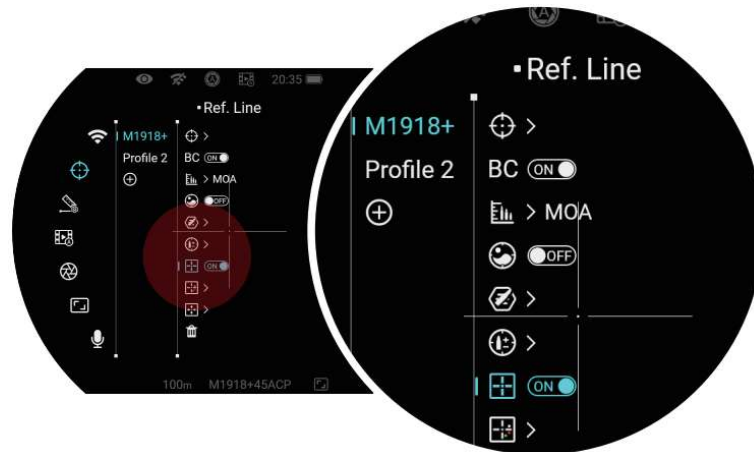

- Set Ref. Line color

The Ref. Line color can be set to Blue/ Green/ Red/ White/ Black

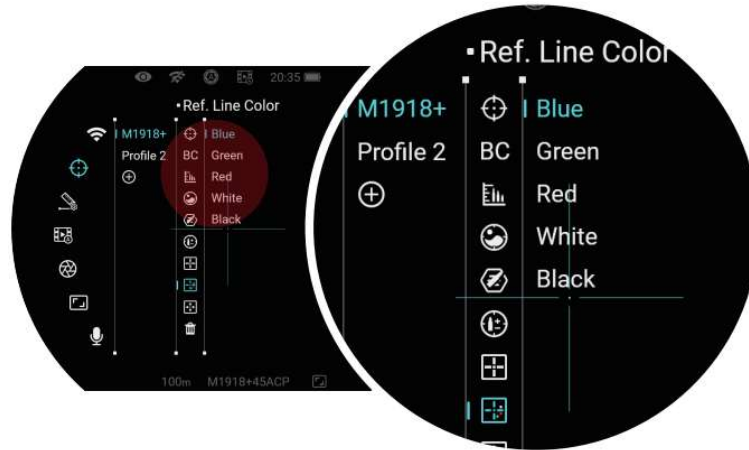

- Ref. Line calibration

You can calibrate the Ref. Line to coincide with the crosshairs of the day scope



- Delete the current profile

You can delete the profiles that are not currently in use.

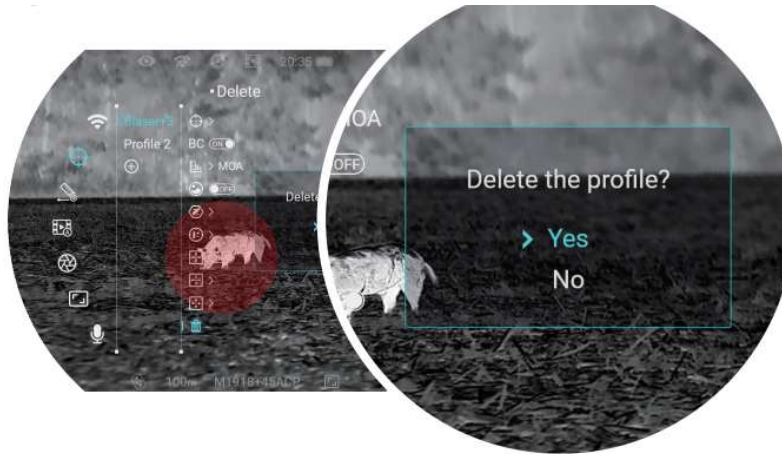

- Within the Laser Rangefinder option, you can change the Color of LRF Mark.
- Within the Laser Rangefinder option, you can change the Brightness of LRF Mark.

Laser Rangefinder



- Continuous LRF can be set ON or OFF,
 - When Continuous LRF is ON ,
 - Short press Up button , perform a single ranging , **SGL: xxxm** will be displayed ;

Long press Up button , perform a continuous ranging , **CONT: xxxm** will be displayed. BC is disabled in continuous ranging mode ;

➤ When Continuous LRF is OFF ,

Short press Up button , perform a single ranging , **SGL: xxxm** will be displayed ;

Long press Up button , move the LRF Mark to the target, then release the Up button to trigger a single ranging, and **SGL: xxxm** will be displayed;



Recoil



- Within the Recoil option, you can set Recoil Activated Video ON or OFF.

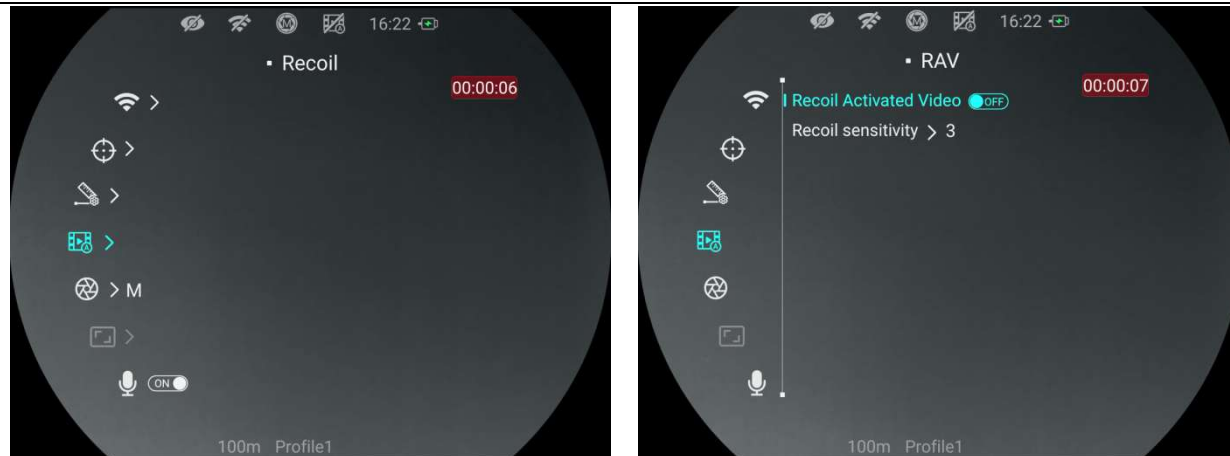

- When RAV is enabled, shooting automatically triggers video recording. The device will save the video footage 10 seconds before and 20 seconds after the shot.
 - The video recorded by long pressing the Down button is named **VID_xxx**;
 - The video recorded by RAV trigger is named **RAV_**;
 - When the RAV_ video is generated, a video named **_SLOW** is also generated. It is a slow-motion video of the bullet shooting moment, which can be used to view the details of hitting the target.

 RAV_165332.mp4

 RAV_165332_SLOW.mp4

 VID_165339.mp4

- You can set different sensitivity in the Recoil sensitivity option , there are 6 levels of recoil sensitivity to choose from.
The smaller the value, the easier it is to trigger the recoil recording, which is suitable for a smaller bullet.
The larger the value, the harder it is to trigger the recoil recording, which is suitable for a larger bullet;
The factory default level is 3 ;







Calibration

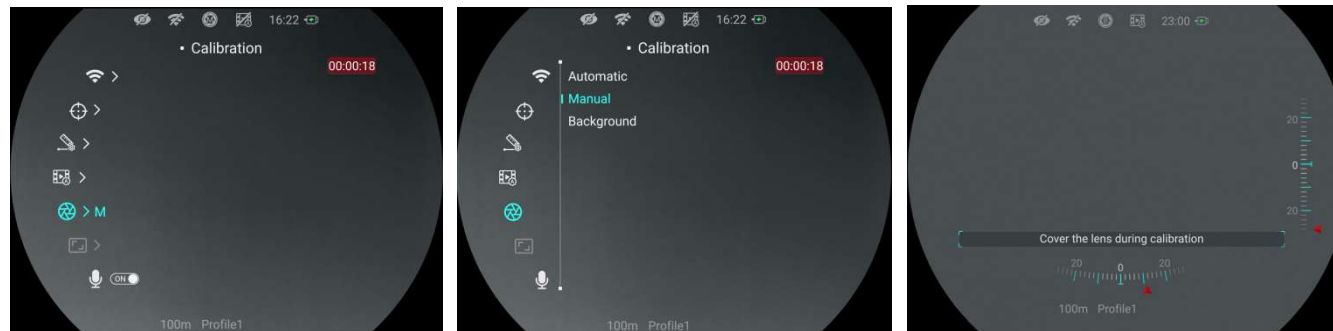

- Within the Calibration option, you can select 3 calibration types, including:
Auto Calibration (A) Manual Calibration (M) Background Calibration (B)
The factory default mode is M.
Note: When performing a Background Calibration, you need to cover the lens cap according to the prompts.



<p>MAGIC ZOOM</p> 	<p>When MAGIC ZOOM is connected successfully, this icon is enabled, and MAGIC ZOOM can be calibrated within this option.</p> <p>When MAGIC ZOOM is not connected, this icon is disabled and gray.</p> <p>Please refer to the MAGIC ZOOM section for details.</p>
<p>Microphone</p> 	<ul style="list-style-type: none"> ● Within the Microphone option, press the Menu button to enable or disable the Microphone. <p>When Microphone is off, there is no sound in the recorded video.</p> 
<p>Standby</p> 	<ul style="list-style-type: none"> ● Within the Standby option, press the Menu button to enable or disable the standby function. ● When Standby mode is enabled, the device will automatically enter Standby mode to save power if the vertical tilt angle exceeds 70° or the horizontal tilt angle exceeds 30°. ● We recommend setting the standby mode as ON, which will extend the battery life, when you find the wild boars, it will automatically wake up and you can aim and shoot quickly.









Pixel Defect Correction

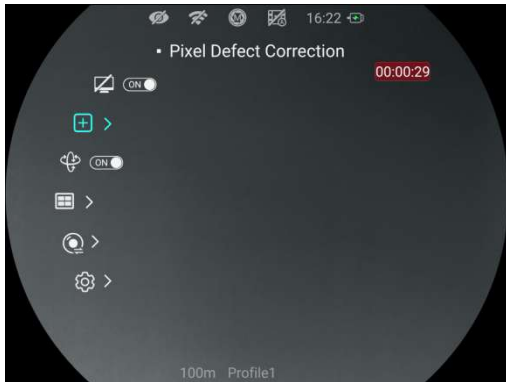

When using the MATE, you may see pixel defects, such as visible light spots or dark spots with stable brightness. To address this problem, use the Pixel Defect Correction function to remove the pixel defects.

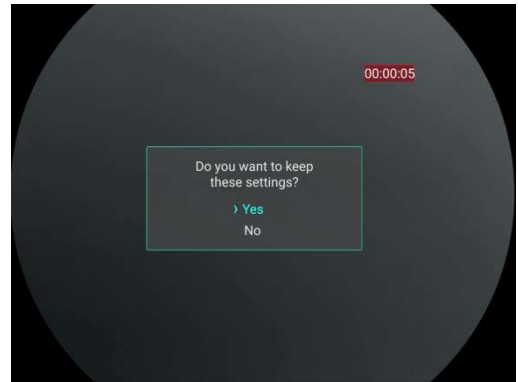
- Within the Pixel Defect Correction option, select  to do automatic Pixel Defect Correction.
- If there are very few Pixel Defect that cannot be corrected by automatic defect correction, you can move the scale to the position of the pixel defect , short press the Menu button to mark or cancel the location marked, the corresponding number will increase or decrease by 1, then long press the Menu button to save and exit.

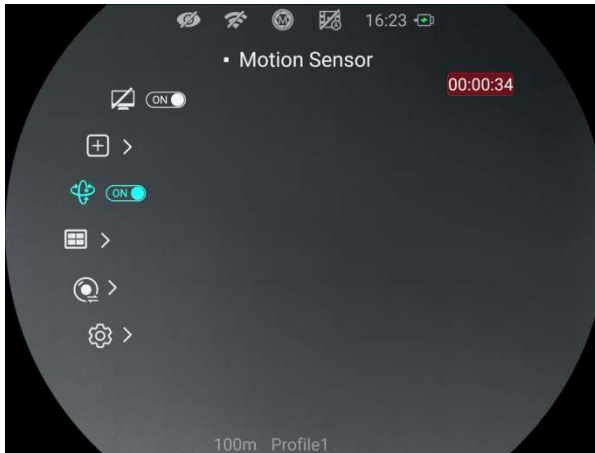

			
<p>Motion Sensor</p> 	<ul style="list-style-type: none"> ● Within the Motion Sensor option, press the Menu button to enable or disable the Motion Sensor. ● When the motion sensor is ON, the horizontal scale representing the tilt angle is displayed on the bottom side, the vertical scale representing the pitch angle is displayed on the right side. 		
			

Gallery



- Within the Gallery, video and photo files are arranged in folders by date.
- After entering a folder, select a video file, and press the M button to play the video file.

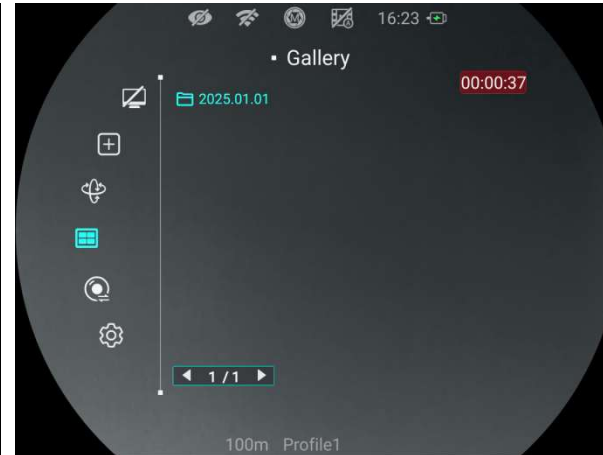
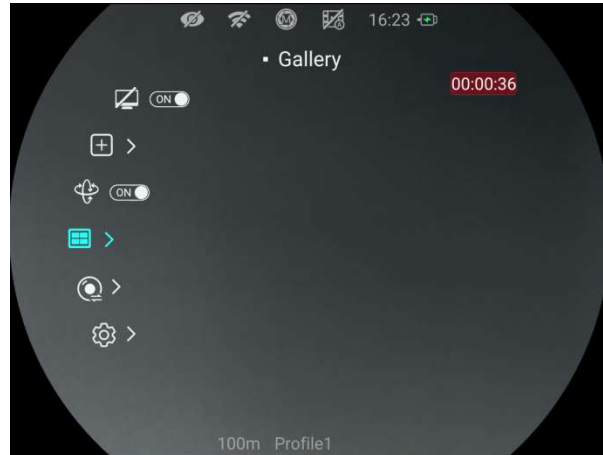





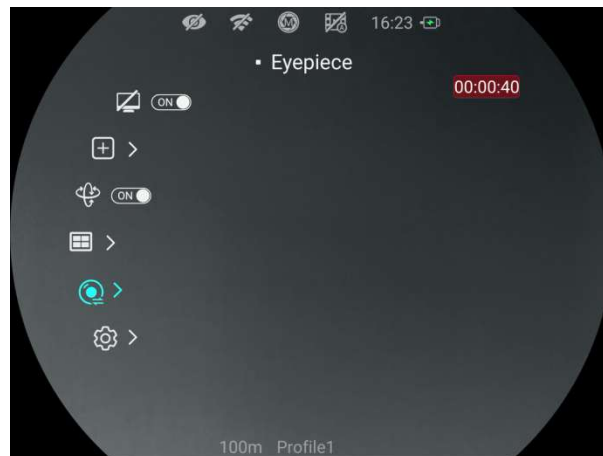

Eyepiece





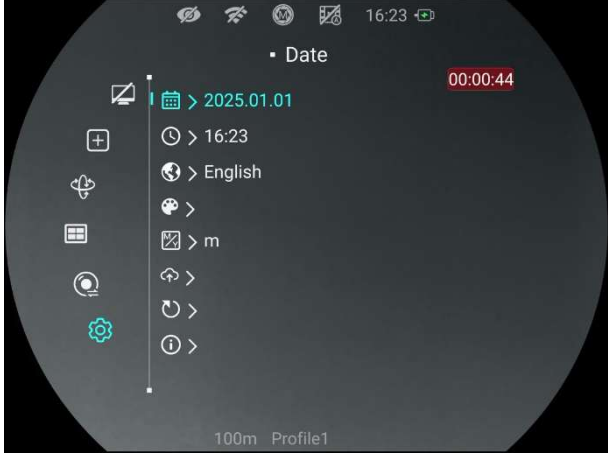

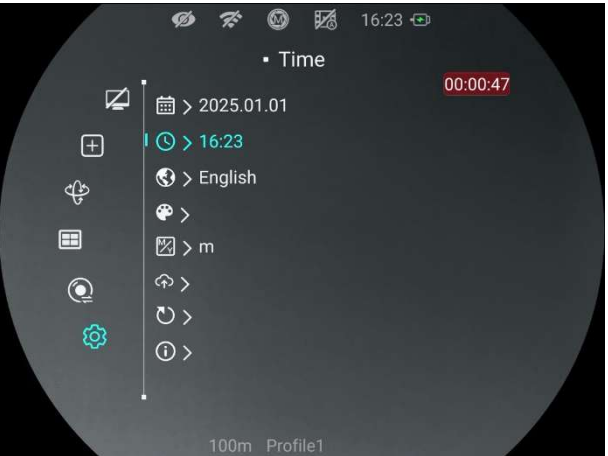

- Within the Eyepiece, you can switch MATE to Clip on mode or Monocular mode.

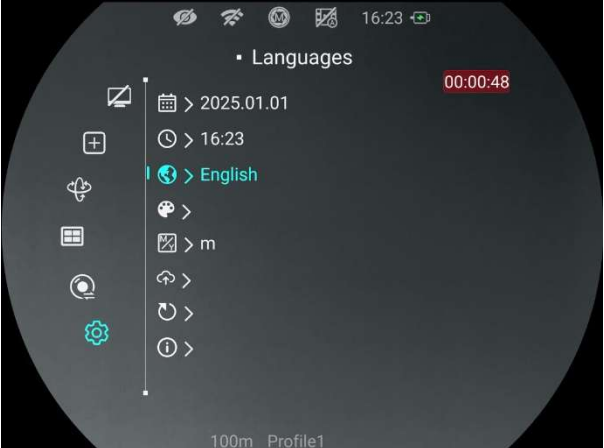

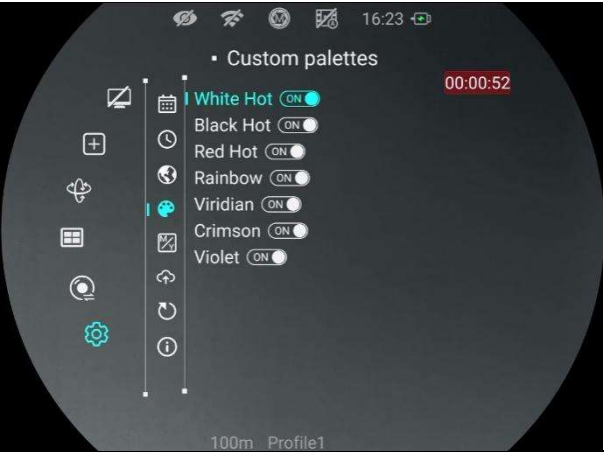

Note: The factory default is Clip on mode. Please make sure that MATE is in Clip on mode before installing on day scope.

<p>Setting</p> 	<p>Date</p> 	<p>Set system date</p> <ul style="list-style-type: none"> ● Within the Date option, short press the Menu button to switch the Year / Month / Day option; ● Press the Up or Down button to adjust the value of Year / Month / Day. ● After the adjustment is completed, press and hold the Menu button to save and exit Date option. 	
	<p>Time</p> 	<p>Set system time</p> <ul style="list-style-type: none"> ● Within the Time option, short press the Menu button to switch the Hour / Minute option; ● Press the Up or Down button to adjust the value of Hour / Minute. ● After the adjustment is completed, press and hold the Menu button to save and exit Time option. 	
	<p>Languages</p> 	<p>Set system languages</p> <ul style="list-style-type: none"> ● Within the Languages option, press the Up or Down button to switch different languages. ● Languages available for the MATE series include English, Deutsch, Italiano, Français, Español, Čeština, 	

		<p>Polski, Svenska, Magyar, Portugues, Nederlands, Norsk, Slovenčina, eesti keel, latviski, lietuvių, български, Dansk</p> <ul style="list-style-type: none"> ● After the adjustment is completed, press and hold the Menu button to save and exit Languages option. 	
	<p>Custom Palettes</p> 	<ul style="list-style-type: none"> ● Within the Custom Palettes option, you can set each palette to ON or OFF. ● You can set the color palettes you frequently use to ON and the other color palettes you rarely use to OFF, which makes it easier to switch color palettes in the shortcut menu. 	
	<p>Unit</p> 	<p>Set system unit</p> <ul style="list-style-type: none"> ● Within the Unit option, press the Up or Down button to switch the unit of Meter or Yard. ● Press Menu button to select Meter / Yard. ● After the adjustment is completed, press and hold the Menu button to save and exit Unit option. 	

		<p>The units of LRF and Zeroing distance will be set to meters or yards.</p>	
	<p>Firmware Update</p> 	<p>Firmware Update</p> <ul style="list-style-type: none"> ● Within the Firmware Update option, you can use the manufacturer-provided specific file to update the system firmware. Of course, you can also upgrade the system through the NOCPIX APP. <p>Notes: When using the firmware update function, please strictly follow the manufacturer's instructions.</p>	

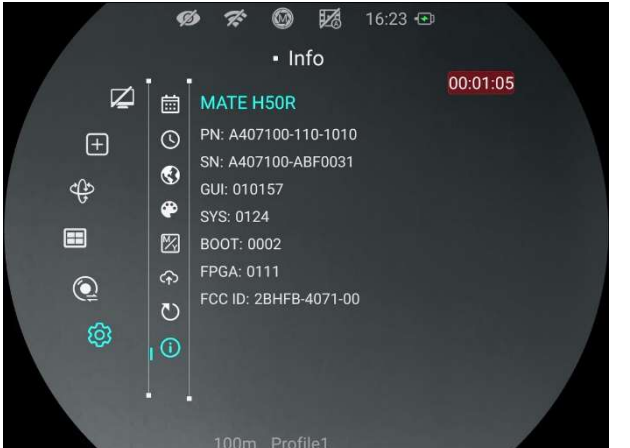
	<p style="text-align: center;">Factory Reset</p> 	<p>Factory reset</p> <ul style="list-style-type: none"> ● Within the Factory Reset option, you can set MATE to factory default settings. 	
	<p style="text-align: center;">Info</p> 	<p>System information</p> <ul style="list-style-type: none"> ● Within in the Info option, you can press the Menu button to enter the Info interface to View the device information. 	

19 FW Updates and APP

The MATE series allow you to transmit images to a smartphone or tablet via Wi-Fi in real time mode.

Continuous improvements will be made to improve the user experience. The latest programs can be automatically detected and updated via the Nocpix APP.

Also, it is feasible to download and update from the official website:

www.nocpix.com.

About Nocpix

You can download and install the Nocpix APP on the official website (www.nocpix.com) or the app store. Alternatively, you can scan the QR code below to download it for free.

- Open the Nocpix APP after installation.
- If your device has been connected to a mobile device, please turn on the mobile data of the mobile device. After connection, an update prompt will be displayed automatically on the App.
- Nocpix automatically registers the last connected device.

Therefore, once you have connected with Nocpix before, it will automatically detect the update even when the scope is not connected to the mobile device.

- If an update is available and the mobile device accesses the Internet, you can download the update first. Then when the device is connected with the mobile device, it will be updated automatically.
- After the update is installed, the device will restart automatically.



20 Maintenance

The maintenance should be carried out at least twice a year and

includes the following steps:

- Wipe the surface of metal and plastic parts to clear off dust and dirt by using a cotton cloth. Silicone grease may be used for the cleaning process.
- Clean the electric contacts and battery slots on the device using a non-greasy organic solvent.
- Check the glass surface of the eyepiece and lens. If necessary, clear off the dust and sand on the lens (it is perfect to use a non-contact method). Use a specialized wiping tool and solvent to clean the optical surfaces.

21 Troubleshooting

The following table lists all problems that are likely to occur during device operation. Check and address problems by referring to this table. If faults not included in this table occur or you cannot fix the fault, return the device to its vendor or supplier for troubleshooting.

Fault	Possible Causes	Solution
The scope cannot be started.	The battery is out of charge.	Charge the battery.
The device cannot be powered by using an external power supply.	The USB cable is damaged.	Replace the USB cable.
	The external power supply is insufficient.	If necessary, check the external power supply.
Images are unclear, vertical lines are present, or the background is not even.	Calibration is required.	Calibrate the images as instructed in this User Manual.
The image is too dark.	The screen is not bright enough.	Adjust the display brightness.
The icons are clear but the image is blurry.	The lens is not focused.	Rotate the lens focus ring to adjust the focus.
	The inner or outer optical surface of the lens is dusted or iced.	Wipe the outer optical surface by using a soft cotton cloth or leave the scope to dry in a warm and dry environment for more than 4 hours.
The scope cannot focus.	Wrong settings.	Set the scope according to the contents of section Power-on and Settings in this user manual. Check the outer surface of the objective lens and eyepiece, and if necessary, wipe off any dust and frost on it.

		In cold weather, a special antifogging coating can be applied (such as those used on eyeglasses or car rearview mirrors).
The device cannot connect to the mobile device.	The Wi-Fi password is incorrect.	Enter the correct password.
	Too many Wi-Fi networks around the device.	Move the device to an area with no or fewer Wi-Fi signals.
Wi-Fi signals are lost or interrupted.	The device is beyond Wi-Fi coverage. There is blocking (such as concrete walls) between the device and the receiver.	Move the device to a place where you can receive Wi-Fi signals.
The observed target disappears.	Observation through glass.	Observe the target directly without the presence of glass.
The image quality is poor or the detection range is shortened.	These problems are likely to occur when you use the device in harsh weather (such as snow, rain, and fog).	
When the device is used at a low temperature, the imaging quality is poorer than that at a normal temperature.	<p>At temperatures above 0°C, the temperature rise varies with the observed objects (environment and background) due to different heat conductivity coefficients. As a result, high-temperature contrast occurs and the image quality is better.</p> <p>At low temperatures, the observed targets (background) usually cool down to a similar temperature because of reduced temperature contrast. Therefore, the image quality (details) is poor, which is a characteristic of thermal imaging devices.</p>	

22 Legal and Regulatory Information

Wireless transmitter module frequency range:

WLAN: 2.412-2.472 GHz

Wireless transmitter module power < 20 dBm



We Inlumen Technologies Co., Ltd. hereby declares that the radio equipment types MATE is in compliance with the Directives 2014/53/EU and 2011/65/EU

FCC Statement

FCC ID: 2BHFB-4071-00

Labeling requirements

This device complies with part 15 of the FCC Rules. Operation is subject to the following two conditions: (1) This device may not cause harmful interference, and (2) this device must accept any interference received, including interference that may cause undesired operation.

Information to the user

Any Changes or modifications not expressly approved by the party responsible for compliance could void the user's authority to operate the equipment.

EMC: Class A

Note: This equipment has been tested and found to comply with the limits for a Class A digital device, pursuant to part 15 of the FCC Rules. These limits are designed to provide reasonable protection against harmful interference when the equipment is operated in a commercial environment. This equipment generates, uses, and can radiate radio frequency energy and, if not installed and used in accordance with the instruction manual, may cause harmful interference to radio communications. Operation of this equipment in a residential area is likely to cause harmful interference in which case the user will be required to correct the interference at his own expense.

To comply with RF exposure requirements, a minimum separation distance of 0.00 cm must be maintained between the user's body and the handset, including the antenna.



 **Manufacture:** Inlumen Technologies Co., Ltd.

 **E-mail:** service@nocpix.com

 **Website:** www.nocpix.com

 **Address:** Room 806, A1, Phase 3, Innovation Industrial Park, High-tech Zone, Hefei City, Anhui Province, China.